

Preformed Metal Roof And Wall Systems

OUR PANELS MAKE THE *difference*



Metal Roof and Wall Systems

www.mbc.com



MBCI has earned its reputation as one of the nation's leading suppliers of preformed metal for roofs, walls, mansards and soffits by providing only THE highest quality building components and service in the industry.

Project Service

From concept to completion, MBCI's Project Service Department is staffed and prepared to provide professional assistance to the architectural and contracting community. From the initial project concept, Project Services will assist in developing budget criteria and product selection to drafting and shop drawings.

Technical

MBCI is in conformance with metal and finish coating standards. Physical properties are available on request. MBCI is committed to an aggressive, independent physical testing program to continually comply with guidelines on water penetration, uplift rating and structural performance. Complete design and reference details are contained in specific product technical manuals. These valuable details will enable you to specify your projects completely and quickly.

Green

MBCI's metal roofs are energy efficient, recyclable, durable, lightweight and cost effective. Our panels are made from 25-35 percent recycled materials and are 100 percent recyclable. Cool metal roofing offers energy savings benefiting both economical and environmental concerns. As a proud Energy Star Partner, many of our Cool Roof colors have reflectivity performance levels that meet Energy Star criteria for roof pitches greater than 2:12. In addition to potential energy savings, our products can help your project gain LEED points.

Single Source™ Warranty

When you specify one of MBCI's Single Source Warranties, you can have confidence that your project will be covered by the most comprehensive warranty available. MBCI starts by reviewing and pre-approving the roof geometry. Any design issues can be addressed before the bid is awarded. Once the job is awarded, MBCI will review the shop drawings to ensure that the proper details are being used, based on the roof geometry and environmental conditions of the project. MBCI will also conduct timely inspections to ascertain that the approved details are being used and the roof is being properly installed. Any discrepancies found during these inspections that would prevent issuance of the warranty will be quickly brought to the architect's attention. Should a leak occur after the warranty has been issued, there is only one call to make—to MBCI.

Certified Installer Program

The MBCI Certified Installer courses cover every aspect of putting our sophisticated systems on your roof—from maintenance and handling, weathertightness and technical requirements, to installation steps and specific detail conditions. We believe so strongly that trained installers are vital to the successful completion of a well-built, leak-free roof that we require their full-time presence on the job site when our Single Source™ Warranty is involved.

This Product Application Chart is for general reference only. Not all panels, gauges and widths should be used for these applications. Please call MBCI for the best product for your specific application.

PRODUCT APPLICATION CHART & INDEX

	Roof System	Facade System	Exterior Wall	Interior Wall Liner	Canopy Roof System	Soffit System	Curved Roofs	Equipment Screens	Framing Systems	Page Number
Vertical Leg SSR	•	•						•		4
Curved BattenLok®					•		•			4
Trapezoidal SSR	•									5
Craftsman™	•	•					•			6
FW		•	•	•		•				7
IL				•						7
ILM				•						7
ShadowRib™		•	•					•		8
NuWall®			•					•		8
Designer™ Series		•	•					•		9
QwikLok™					•	•				10
Classic®					•	•				10
Artisan®				•		•				11
FlexLoc®		•				•	•	•		12
7.2 Panel	•	•	•	•				•		13
LiteFrame®									•	13
NuRoof®			•						•	14

Descriptions and specifications contained herein were in effect at the time this publication was approved for printing. In a continuing effort to refine and improve products, MBCI reserves the right to discontinue products at any time or change specifications and/or designs without incurring obligation. To ensure you have the latest information available, please inquire or visit our website at www.mbc.com. Application details are for illustration purposes only and may not be appropriate for all environmental conditions, building designs or panel profiles. Projects should be designed to conform to applicable building codes, regulations and accepted industry practices. If there is a conflict between this manual and project erection drawings, the erection drawings will take precedence.

DESIGNER™ SERIES

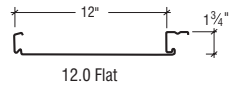
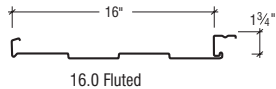

SHADOWRIB™

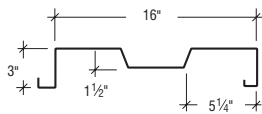

NUWALL®

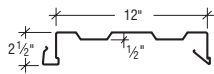

WALL / LINER PANELS

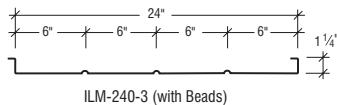
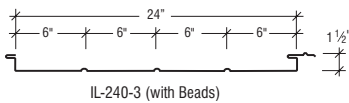
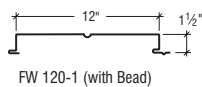

ARTISAN® SERIES

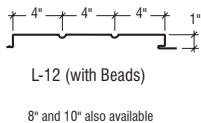
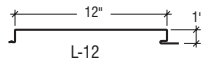

CLASSIC® SERIES

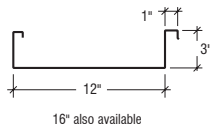

QWIKLOK™

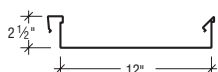

FLEXLOC®

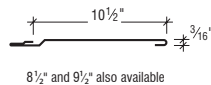

CRAFTSMAN™ SERIES

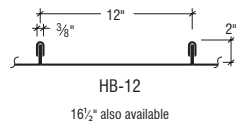
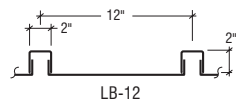
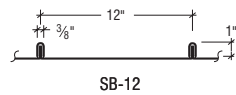

Standing Seam Vertical Leg

LOKSEAM®

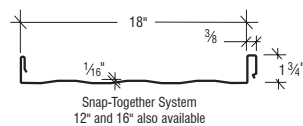

BATTENLOK® HS

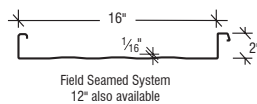

SUPERLOK®

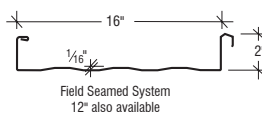

CURVED BATTENLOK®

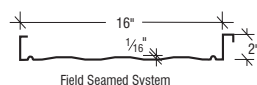

Trapezoidal Leg

ULTRA-DEK®

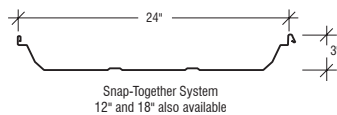

DOUBLE-LOK®

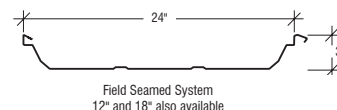

Materials and Coatings

The base metal is 26-, 24- or 22-gauge steel manufactured from either high-strength Galvalume® produced to ASTM A792/A792M-AZ50 or AZ55, Grade 50; or HDG produced to ASTM A653/A653M-G90 Structural Quality Grade 50, Grade D structural strength. Color Bond is 24-gauge HDG, treated or wiped to produce a fully alloyed zinc-iron coating intended for field painting after proper cleaning and priming. Also available: Metals—aluminum; Finishes—baked enamel, urethane, plastisol. All materials are available smooth or stucco embossed.

All metal architectural panels have wide, flat surfaces to meet the demands of today's design. While MBCI has recognized and responded to this requirement, we have a responsibility to point out that a wide and perfectly flat appearance is not always possible. In some wide products, panel distortion, called oil canning, may occur and require additional aesthetic tolerance and/or additional support behind the panel face. Heavier gauges, narrower widths, striations and embossing minimize oil canning.

Trim and Flashing

All trim and flashing is available in the same gauge and finish as panels. A complete selection of standard trim and made-to-specification flashing in lengths to 20'-3" is available. All flashing is designed to minimize exposed fasteners.

Paint Finishes

MBCI offers one of the largest color selections in the industry in a choice of three paint systems. Each color that MBCI offers qualifies as a Cool Roof on high sloped roofs above 2:12.

Signature® 300/Signature® 300 Metallic

This fluorocarbon paint system combines ceramic pigmentation with polyvinylidene fluoride (70% of resin solids) for a superior, long-lasting finish. Outstanding performance and durability are achieved through this proprietary resin technology. Signature® 300 is recognized as providing unsurpassed performance in critical areas such as color retention, film erosion rate and chemical resistance.

Signature® 200

Signature® 200 is a thermoset coating system composed of polyester resin modified by copolymerization with a functional silicone resin intermediate. With high quality ceramic pigmentation, Signature® 200 offers optimum exterior protection plus superior resistance to chemical corrosion and ultraviolet radiation. Signature® 200 represents the most sophisticated silicone polyester coating system in the industry.

Warranties

Twenty-five year limited warranties are available upon written request and project qualification (outside the Continental United States, please inquire).



LokSeam®

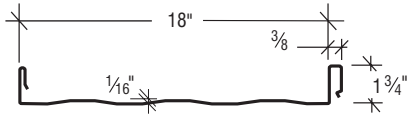

12" and 16" also available

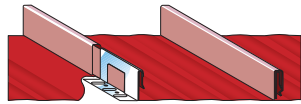

LokSeam® Interlock

BattenLok® HS, SuperLok® Curved BattenLok®

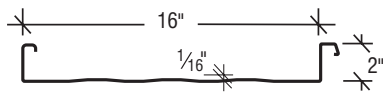

12" also available

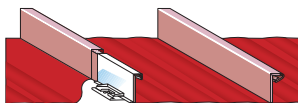

BattenLok® HS Interlock

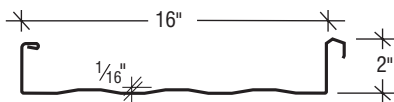

12" also available

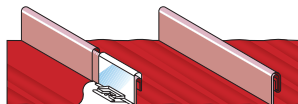

SuperLok® Interlock

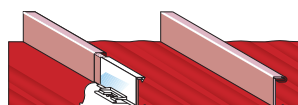
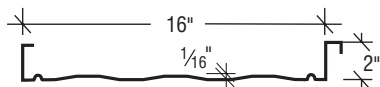

Curved BattenLok® Interlock

Consult the MBCI DESIGN/INSTALLATION INFORMATION MANUAL for proper application and design details and other product information.



Vertical Leg Structural Standing Seam Roof Systems

The LokSeam®, BattenLok® HS, SuperLok® and Curved BattenLok® standing seam roof systems blend the aesthetics of an architectural panel with the strength of a structural panel. These panels have earned several uplift ratings assuring the reliability of performance. The designer is afforded a flexible tool to meet any design challenge.

Architectural/Structural Panels

LokSeam® is a snap-together system that can accommodate transitions from roof to fascia for a continuous, uninterrupted appearance. A die-formed rib cover is available for use with this detail. BattenLok® HS is a field-seamed system that is also capable of transitioning from roof to fascia. Die-formed rib covers are also available for this product. SuperLok® is a field-seamed panel that combines a slim rib with exceptional uplift resistance. This panel has been designed to withstand the most rigorous conditions. Each of these systems features factory-installed mastic to ensure weathertight seams. Curved BattenLok®, available in 16", may be curved to a minimum radius of 20', and being a structural panel, may be installed over open framing or solid decking. Striations are standard for added aesthetic value.

Concealed Fastening System

A choice of concealed fastening clips is available for each panel system including UL rated clips. These clips hold the panels firmly in place without unsightly exposed fasteners. Each clip system offers the ability to accommodate thermal movement.

Uplift Ratings

Each system carries the Underwriters Laboratories (UL 90) Fire Resistance and Wind Uplift ratings covering a wide range of roof designs. In addition, the SuperLok® system meets a variety of ratings as tested under Factory Mutual Research Corporation Standard 4471. The BattenLok® HS, SuperLok® and Curved BattenLok® systems have met all test requirements specified in CECS 07416/ASTM E1592 Standing Seam Metal Roof System guide specification. Contact MBCI for information relating to each panel profile.

Application

Each of these systems is designed to be installed over open framing. However, the MBCI LiteFrame®, 5/8" plywood or a composite roof assembly may be used as alternate substructures. LokSeam® must be installed on roof slopes of 3:12 or greater. BattenLok® HS and SuperLok® must be installed on roof slopes of 1/2 :12 or greater.

Trapezoidal Structural Standing Seam Roof Systems

The snap-together system, Ultra-Dek®, and field-seamed system, Double-Lok®, were designed from concept to installation for strength, durability and weatherability. The standing seams are three inches above the lowest part of the panel, well above the water level as it flows off the roof. The seams have factory-applied mastic to ensure a secure, weathertight seam.

Begins and Ends in a High

The rake/gable at both ends of each roof system finish with a 3" high standing seam, avoiding the necessity of finishing in the low, flat part of a panel where the greatest possibilities for leaks occur in most other systems.

Concealed Fastening System

The standard offering for the Ultra-Dek® and Double-Lok® systems is a sliding clip that allows for thermal movement. A 4" sliding clip is available for the Double-Lok® system, which can eliminate roof steps on a double slope building up to 900' wide or a single slope building up to 450' wide. These clips are available in high and low versions for use with different thicknesses of vinyl-backed fiberglass insulation.

Uplift Ratings

Both systems carry Underwriters Laboratories (UL 90) Fire Resistance and Wind Uplift ratings covering a wide range of roof designs. In addition, the Double-Lok® system meets Class 1-60, 1-90 and 1-105 ratings as tested under Factory Mutual Research Corporation Standard 4471. The Double-Lok® system has met all test requirements specified in CEGS 07416/ASTM E1592 Standing Seam Metal Roof System guide specification. Contact MBCI for parameters relating to each panel profile.

Application

Panels can be installed before or after the exterior walls are in place, and all trim is attached after the roof is installed. With a recommended minimum slope of 1/4 :12, these roof systems can be used on all types of construction—masonry, metal or wood—for either new construction or retrofit.

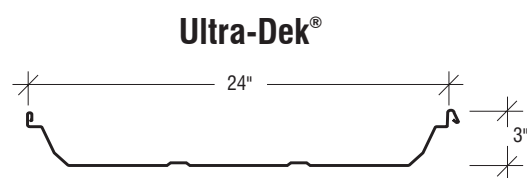

Snap-Together System
12" and 18" also available



Panel Interlock

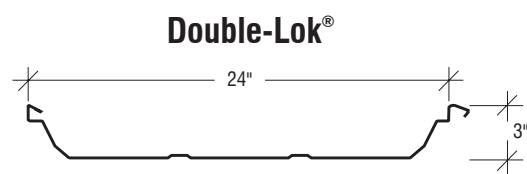

Field-Seamed System
12" and 18" also available



Panel Interlock

Consult the MBCI DESIGN/INSTALLATION INFORMATION MANUAL for proper application and design details and other product information.





Craftsman™ Series

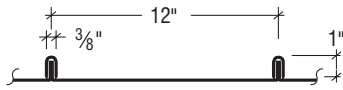

SB-12

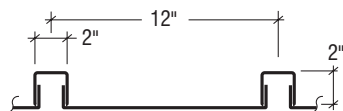

LB-12

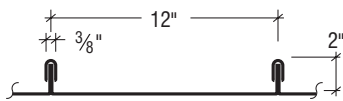

HB-12

16 1/2" also available



Panel Interlock

Consult the MBCI DESIGN/INSTALLATION INFORMATION MANUAL for proper application and design details and other product information.

Craftsman™ Series

The Craftsman™ Series design makes complicated building transitions simple without the necessity of unsightly flashings. Slope changes from roof to fascia to soffit can be made with one continuous pan and batten. Hip, ridge and valley conditions can be designed into any project.

Snap-on Batten

The pan and batten are manufactured separately to maximize design flexibility and ease of installation for difficult hip, ridge or valley conditions. Narrow, wide and high profiles are available: Small Batten (SB), Large Batten (LB) and High Batten (HB).

Concealed Fastening System

Each profile has its own concealed clip that securely locks the batten to the panel while allowing for expansion and contraction.

UL 90 Approved

Each Craftsman™ Series panel carries an Underwriters Laboratories UL 90 Uplift classification installed over 5/8" plywood or a composite roof assembly with a metal subdeck and rigid insulation. For complete information, call MBCI or review UL Construction Numbers 280, 281, 282, 308, 309 and 310.

Application

The Craftsman™ Series is a water-shedding panel system and can be used for roofs and mansards only when installed over a water-proofed solid substructure and the roof has a minimum slope of 3:12. When used for fascias and soffits, either the MBCI LiteFrame® system or a solid substructure can be used.





FW, IL and ILM Panels

Architectural/Industrial Wall & Liner Systems

These concealed fastener wall and liner panels offer an attractive, flat appearance for architectural, commercial and industrial markets. The heavy gauge offering of each panel, available in 24-, 22- and 20-gauge, provides for large spanning capabilities particularly in composite wall applications.

Air Infiltration and Water Penetration

The FW panel has been tested by a certified independent laboratory in accordance with ASTM test procedures for Air Infiltration and Water Penetration at the sidelap. Test results show no air leakage at 1.57PSF and no water penetration at 6.24PSF differential pressure.

Application

The FW Panel can be used in a single skin application or as a component of a composite wall system. The IL Panel profiles allow for installation as the liner of a composite wall system or installed to the inside girts of a building as a concealed fastener interior liner. The ILM liners do not have the interlocking side joint feature of the IL panel and are used as the interior liner in a field-assembled system only. The products are offered with "face beads" and/or embossing to minimize the potential for oil canning.

Field-Assembled Composite Wall Systems

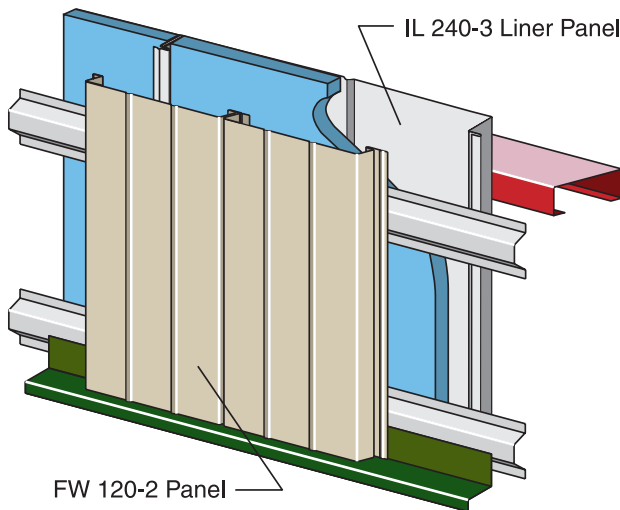

The Composite Wall System is designed to accommodate FW or 7.2 panels as exterior skins with IL or ILM panel interior liners.

FW Wall Panel

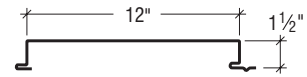

FW 120-0

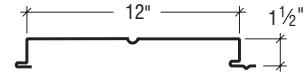

FW 120-1 (with Bead)

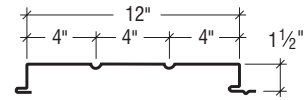

FW 120-2 (with Beads)

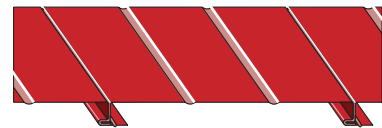

Panel Interlock

Interior Liner Panels

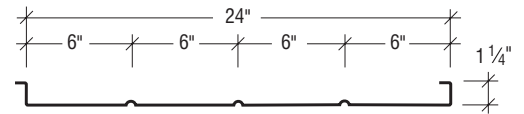

ILM-240-3 (with Beads)

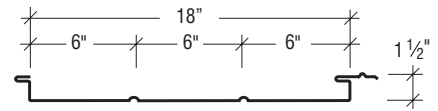

IL-180-2 (with Beads)

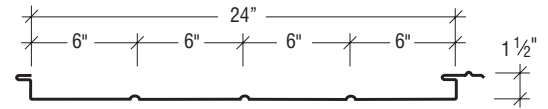

IL-240-3 (with Beads)

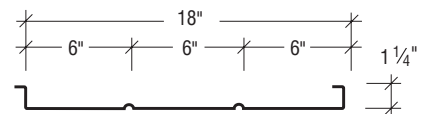

ILM-180-2 (with Beads)



Panel Interlock

Consult the MBCI DESIGN/INSTALLATION INFORMATION MANUAL for proper application and design details and other product information.

Wall Panels

ShadowRib™

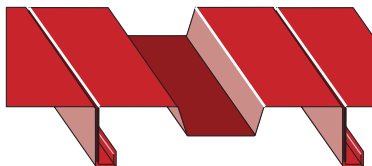
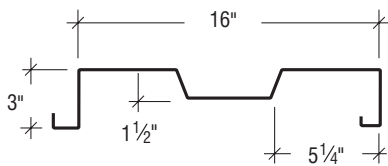

Panel Interlock

Consult the MBCI DESIGN/INSTALLATION INFORMATION MANUAL for proper application and design details and other product information.

ShadowRib™

ShadowRib™ combines aesthetics, economics and function to bring definition to metal structures. ShadowRib™ is a proven performer and a versatile tool to the designer.

Architectural Profile

Structural strength in the ShadowRib™ is accomplished without sacrificing appearance or design flexibility. The fluted face creates distinctive shadow lines

Concealed Fastening System

Panels may be secured to the structure from the outside of the building with the ShadowRib™ concealed clip or from inside the building with an expansion fastener. Both are positive fastening methods that create a secure interlock between panel and structure.

Application

The ShadowRib™ panel can be used for walls, fascias and equipment screens. Apply the panel over light gauge framing, purlins, girts, structural steel and joists.

NuWall® Panel

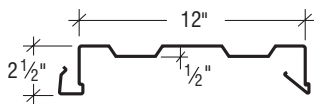

Panel Interlock

Consult the MBCI DESIGN/INSTALLATION INFORMATION MANUAL for proper application and design details and other product information.

NuWall®

NuWall® combines the ease of installation in both new or retrofit applications with a pleasing aesthetic appeal. The shadow lines created with the NuWall® panel will enhance any structure's appearance. Installation of panels for retrofitting is performed completely outside with no disruption of the workplace on the inside.

Concealed Fastening System

The panel is attached to the structure with self-drilling fasteners on one side of the panel only. No clips are required. The adjoining panel simply snaps into the previous panel, concealing the fasteners from view.

Application

NuWall® is ideal for both new and retrofit applications. In retrofit applications, the NuWall® panel can be installed over an existing "R" panel wall. This saves both labor and material. Other panel profiles and other forms of construction may require the use of subgirts.





Wall Panel

Designer™ Series

The Designer™ Series panels offer the toughness of metal to create an attractive, flexible and functional wall or fascia panel. The Designer™ Series is offered in fluted and flat profiles which are equally effective for new construction or retrofit of existing buildings.

Designer™ Series 16.0 Fluted Panel

The Designer™ Series 16" Fluted Panel offers a continuous rib design with a hidden side lap where the panels join together. Ribs are 4" wide and $\frac{3}{8}$ " deep which provide interesting shadow lines along the length of the wall. The panel legs are $1\frac{3}{4}$ " deep allowing ample space for rigid board, blanket or batt insulation in the cavity.

Designer™ Series 12.0 Flat Panel

If your design calls for a smooth or flat wall or fascia, look to the Designer™ Series 12" Flat Panel. The $1\frac{3}{4}$ " deep legs offer a perfect cavity for rigid-board insulation in addition to making it ideal for retrofit or new construction.

Concealed Fastening System

Each panel features concealed fastening systems enhancing the appearance. One leg of the panel is attached to the structural using a concealed clip and the other leg snaps securely into the adjoining panel to lock them into position.

Designer™ Series

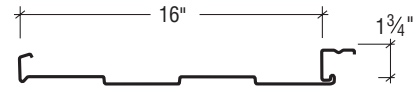

Fluted Panel Interlock

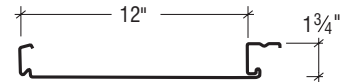

Flat Panel Interlock

Consult the MBCI DESIGN/INSTALLATION INFORMATION MANUAL for proper application and design details and other product information.





QwikLok™

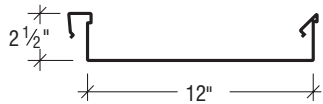

Panel Interlock

Classic® Series

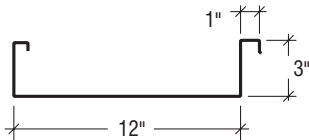

P12 (ROOF)
16" also available



Panel Interlock

Consult the MBCI DESIGN/INSTALLATION INFORMATION MANUAL for proper application and design details and other product information.

UNDERHUNG CANOPIES

QwikLok™

QwikLok™ provides the basic design element for any type of canopy cover. Easy-to-trim flush surfaces make transitions to conventional material simple without major concern for creating “special” conditions. Direct the flow of water to any desired drainage point by combining QwikLok™ with the MBCI fascia/gutter. Canopies, walkway covers and soffits are all in the QwikLok™ design arena. High gloss finish, immense water carrying capacity and long span characteristics make QwikLok™ today’s most popular choice for any underside application.

Concealed Fastening System

The panel is attached to the structure with the MBCI one-step fastening method. One-step fastening requires only one side of the panel to be attached to the structure. The adjoining panel is snap-locked to the first panel, concealing the fastener from view and providing a secure, flush appearance. This proven fastening method creates a positive interlock between panels.

Application

QwikLok™ is ideal for underhung applications. No more fighting with trying to install two panels at one time. Unlike conventional roofing cover, QwikLok™ can be assembled from the underside of the structure one panel at a time, producing a flush appearance with no exposed fasteners. Install QwikLok™ over a variety of substructures such as light gauge framing, purlins, structural steel and joists.



Classic® Series

The Classic® Series is a time-tested performer! Through the years these panels have been used for roofs, canopies, walkway covers and soffits. Proven capabilities make this a versatile and valuable design tool.

Canopy

The Classic® Series creates a clean, flush appearance when used as a canopy system.

Concealed Fastening System

Panels may be secured to the structure by using clips or expansion fasteners. Both are positive fastening methods that create a secure interlock between panel and structure.

Application

This versatile panel can be attached to the bottom of the roof structural system whether it is light gauge framing, purlins, structural steel or joists.



Artisan® Series

The simplicity of the Artisan® Series panel is its best design feature. Uniform dimensions and clean appearance allow the designer to plan modules, eliminate complicated pieces and follow wall curvatures. The Artisan® panel can be vertical, horizontal, perpendicular or skewed to the building line, allowing the designer multi-dimensional freedom to create.

Concealed Fastening System

Artisan® Series panels use the positive fastening method and are attached directly to the substructure. The fastener is concealed behind the flush face.

Application

The Artisan® panels are used for soffits and interior liners. These panels can be attached to the MBCI LiteFrame® system or waterproofed, solid substructure.

Artisan® Series

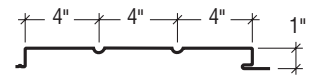
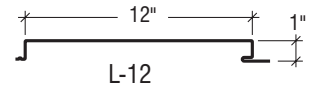

L-12 (with Beads)

8" and 10" also available



Panel Interlock

Consult the MBCI DESIGN/INSTALLATION INFORMATION MANUAL for proper application and design details and other product information.



FlexLoc®

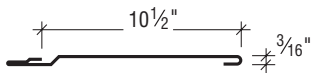

8 1/2" and 9 1/2" also available

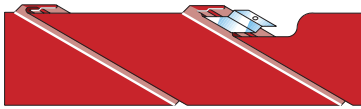

Soffit



Barrel Vault Roof

Panel Interlock

Consult the MBCI DESIGN/INSTALLATION INFORMATION MANUAL for proper application and design details and other product information.

FlexLoc®

The FlexLoc® panel system combines a clean, flat appearance with an easy-to-engage seam. The FlexLoc® is an ideal system for curved applications as well as a soffit system.

Concealed Fastening System

The FlexLoc® system is attached to the substructure by concealed clips with a low-profile pancake head fastener.

Application

FlexLoc® panels can be used for soffit systems or barrel vault roofs. On barrel vault roofs, FlexLoc® panels should be attached to a water-proofed, solid substructure. When used as a fascia, panels can be applied to open framing such as the MBCI LiteFrame™ system.



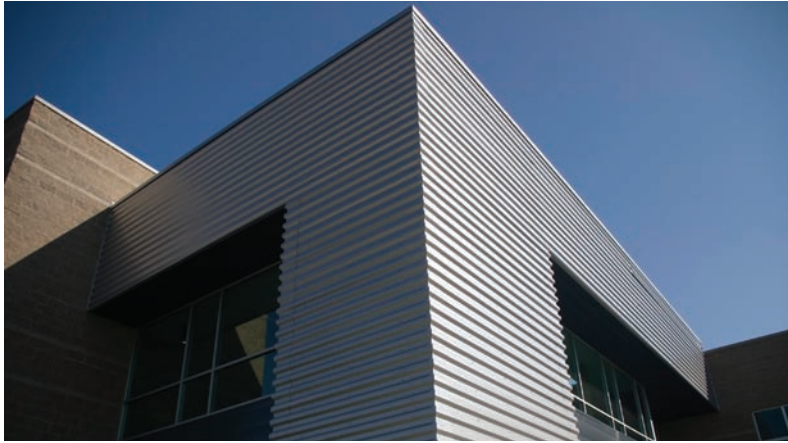

7.2 Panel

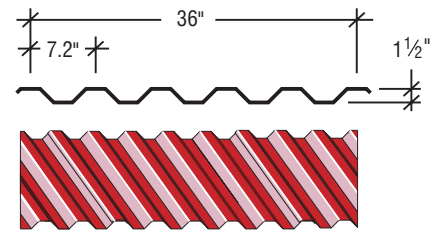

Panel Lap

Consult the MBCI DESIGN/INSTALLATION INFORMATION MANUAL for proper application and design details and other product information.

7.2 Panel

When your design calls for an industrial/commercial thru-fastener panel, 7.2 Panel is a versatile panel system for roofs, walls and even carports. 7.2 Panel is a 36" wide panel with symmetrical 1 1/2" high ribs on 7.2" centers. This rugged panel is available in 29- through 22-gauge steel and offers excellent spanning capability.

LiteFrame[®]

Flexibility is the key to establishing discriminating profiles for mansard and fascia applications. LiteFrame[®] gives the designer total control to create shapes that enhance building character. Virtually any combination of hat sections, channel sections and sub-girts can be made, allowing the designer to make a statement with stature and style. This light gauge structural framing was designed for preformed metal panels. MBCI precision rollforms LiteFrame[®] in 20' lengths.

Application

Hat sections and channel sections are easily assembled to make strong structural-type framing members. All frames are stabilized and made true to avoid panel distortion.

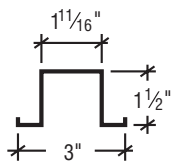

HAT SECTION

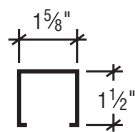

CHANNEL SECTION

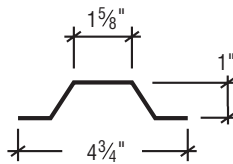

SUB-GIRT



NuRoof®

If you have roof problems due to leaks, high maintenance costs and low energy efficiency, the MBCI NuRoof® Retrofit System is the remedy. With the NuRoof® framing system, you can design a sloped roof using a variety of MBCI roof panel systems that will fit right over most old, existing roof.

NuRoof® UL 90/Load Requirements

The NuRoof® framing system has been designed to allow for a UL 90 rating using certain spacing requirements as well as meeting a variety of live and wind load requirements.

Application

Design flexibility affords the designer choices of roof slopes, hips, valleys and gable endwalls. Roof systems are available in a variety of profiles, widths, gauges, paint finishes and colors offering even more design flexibility. Contact MBCI for details.

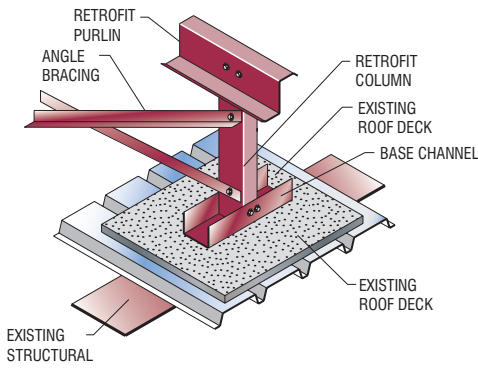

OPTION 1

Option One utilizes a base channel that is attached to the joist or other structural members in the existing roof. This option works well when the existing structural members are parallel to the intended roof slope.

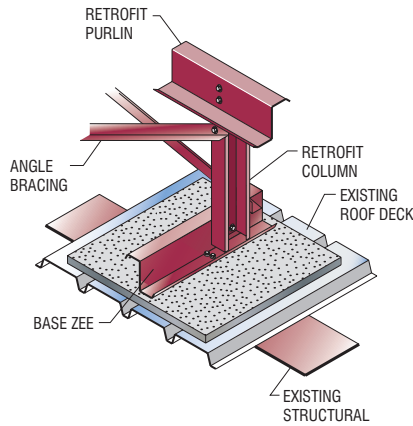

OPTION 2

Option Two utilizes a roof support "Zee" that is attached to the joist or other structural member in the existing roof. This option works well when the existing structural members are perpendicular to the intended roof slope.

Consult the MBCI DESIGN/INSTALLATION INFORMATION MANUAL for proper application and design details and other product information.

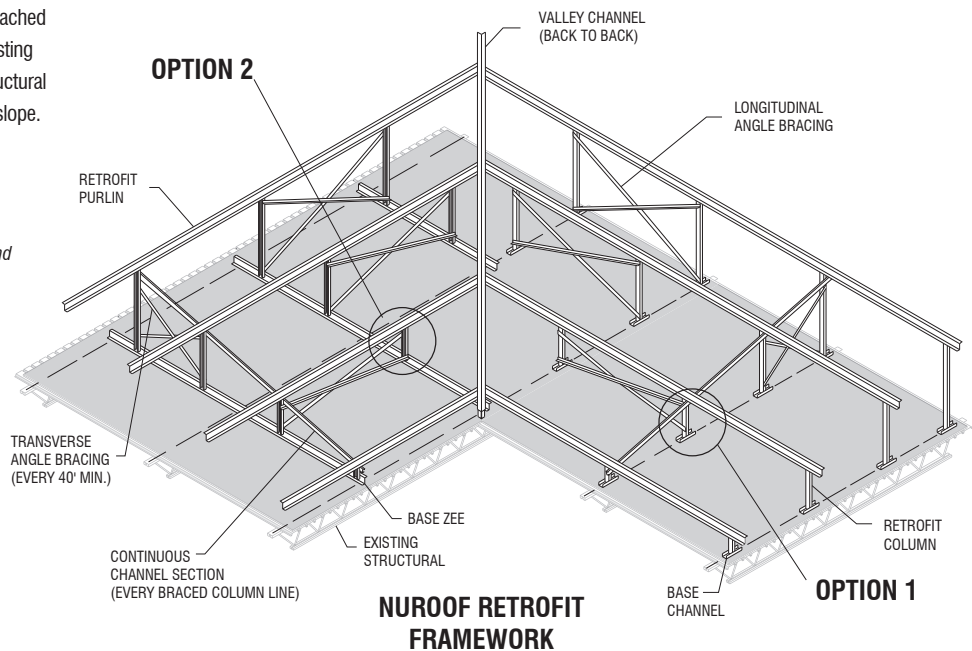

NUROOF RETROFIT FRAMEWORK

PRODUCT SELECTION CHART

PANELS	Signature® 300 Signature® 300 Metallic			Signature® 200			High Gloss White	Color Bond	Galvalume Plus®		
	26 Ga.	24 Ga.	22 Ga.	26 Ga.	24 Ga.	22 Ga.	24 Ga.	24 Ga.	26 Ga.	24 Ga.	22 Ga.
Craftsman™											
12" Wide	■	●	■	●	●	■		●	●	●	■
16 1/2" Wide		●	■		●	■		●		●	■
BattenLok® HS											
12" Wide		■	■		■	■				●	■
16" Wide		●*	■		■	■				●	■
Curved BattenLok®											
16" Wide		●*			■					●	
LokSeam®											
12" Wide		■	■	■	●	■		■	●	●	
16" Wide		●*	■		■	■		■		●	■
18" Wide		●*	■		●	■		●	●	●	
SuperLok®											
12" Wide		■	■		■	■				●	■
16" Wide		●*	■		■	■				●	■
Ultra-Dek® & Double-Lok®											
12" Wide	■	■	■	■	■	■		■	●	●	■
18" Wide	■	●*	■	■	■	■		■	●	●	■
24" Wide	■	■	■	■	■	■		■	●	●	■
FW											
12" Wide		●	■		■	■				●	●
IL-White Only											
18" Wide		●	■		■	■				●	■
24" Wide		●	■		■	■				●	■
ILM-White Only											
18" Wide		●	■		■	■				●	■
24" Wide		●	■		■	■				●	■
ShadowRib™											
16" Wide		●	■		●	■		■		■	■
NuWall®											
12" Wide		■	■	■	■	■		●	●	●	■
Designer® Series											
12" Wide		●*	■		■	■				■	■
16" Wide		●*	■		■	■				■	■
Classic®											
12" Wide	■	■	■	■	●	■		■	■	●	■
16" Wide	■	■	■	■	●	■		■	■	●	■
QwikLok™											
12" Wide	■	■	■	■	■	■	●	■	■	■	■
Artisan®											
8" Wide	■	●	■	●	●	■		●	●	●	■
10" Wide	■	●	■	●	●	■		●	●	●	■
12" Wide	■	●	■	●	●	■		●	●	●	■
FlexLoc®											
8 1/2" Wide		■			■			■		■	
9 1/2" Wide		●			●			●		●	
10 1/2" Wide		■			■			■		■	

● — Available in any quantity. Other colors, finishes, gauges, and materials available, please inquire.

■ — Minimum quantity may be required.

* Signature™ 300 Metallic may require minimum order.

Other Products Available from MBCI

Building Panels

MBCI exposed fastener metal wall and roof panels offer a broad choice of popular profiles. They are suited to a wide range of applications in both conventional and metal building construction.

Standard and Custom Structural Shapes

MBCI manufactures a complete line of structural shapes rollformed to dimensions common to the metal building industry. In addition, custom shapes can also be formed to accommodate specific project requirements.

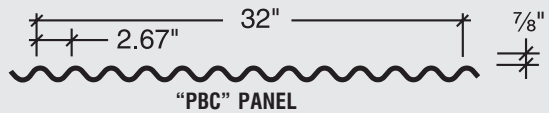
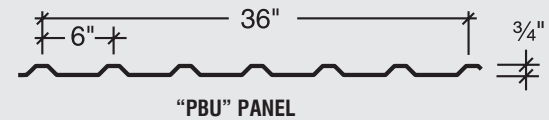

OUR PANELS MAKE THE *difference*



Houston, TX (Corporate) 877-713-6224 | Adel, GA 888-446-6224 | Atlanta, GA 877-512-6224
 Atwater, CA 800-829-9324 | Dallas, TX 800-653-6224 | Indianapolis, IN 800-735-6224 | Lubbock, TX 800-758-6224
 Memphis, TN 800-206-6224 | Oklahoma City, OK 800-597-6224 | Omaha, NE 800-458-6224
 Phoenix, AZ 888-533-6224 | Richmond, VA 800-729-6224 | Rome, NY 800-559-6224 | Salt Lake City, UT 800-874-2404
 San Antonio, TX 800-598-6224 | Tampa, FL (Sales Office) 800-359-6224

For current information, visit our website at www.mbc.com

Descriptions and specifications contained herein were in effect at the time this publication was approved for printing. In a continuing effort to refine and improve products, MBCI reserves the right to discontinue products at any time or change specifications and/or designs without incurring obligation. To ensure you have the latest information available, please inquire or visit our website at www.mbc.com. Application details are for illustration purposes only and may not be appropriate for all environmental conditions, building designs or panel profiles. Projects should be designed to conform to applicable building codes, regulations and accepted industry practices. If there is a conflict between this manual and project erection drawings, the erection drawings will take precedence.

